

Heritage Windows And Doors

Steel Look-a-Like Aluminium Windows And Doors



Duration Windows

Units 4-5,
Charfleets Road,
Canvey Island,
Essex. SS8 0PQ

t: 01268 681612 (15 lines)
f: 01268 510058
e: sales@duration.co.uk
w: www.duration.co.uk



DURATION WINDOWS

Supplying high quality aluminium products since 1985

Traditional Style, Modern Comforts

The Heritage window system is a thermally efficient replacement for steel windows. These windows use the latest technology and are still a fraction of the cost of steel windows. Our Heritage windows use the latest 'Polyamide' thermal barrier technology giving them superior thermal performance.

Now you can easily and affordably replace your old, single glazed, rusty steel windows with non-rusting, secure, steel look-a-like windows with modern energy efficient double glazing. What's more you can do so without compromising the character of your period home. Our Heritage windows will greatly improve the security and insulation of your home, saving you money on your household bills and reducing external noise.

Our ultra slim-line profile emulates the look and feel of traditional steel windows. Whether it is combined with new or original hardwood frames, or fitted directly to brick, these windows can be made to replicate your existing windows.



Features

- Standard colours - white, black/white^(dual colour), black and brown.
- Single and dual colours, custom RAL colours and textured paints are also available.
- Traditional furniture options.
- Modern multi-point locking options including Chelton Secure™.
- Slim-line 47mm polyamide thermally broken, non-rusting aluminium profile.
- Can be supplied unglazed or glazed for 24mm sealed unit.
- Vents are internally glazed for security, and ease of installation.
- Trickle vents available in head extension.
- Outer frame: 36mm; Outer frame - Sash: 56/59mm;
- Optional dummy vents for matching internally glazed fixed lites.
- Complies to building regulations, making this window suitable for new build as well as replacement or refurbishment projects in listed buildings and conservation areas.



Curved Aluminium



Astragal Bars



Profile Related Butt Hinges



Friction Hinges & Dummy Butts



Easy Clean, Fire Escape Hinges

Traditional Furniture With Modern Locking

Why can't you have both modern high security locking and maintain the look of your old steel window handles? With our Heritage windows you can! The furniture available for our Heritage windows looks traditional but drives modern multi-point locking, such as our patented Chelton Secure or Espag locking. Using our locking the security of your home is increased while maintaining your period look.

You are not limited to just heritage style furniture, you can also specify modern style handles for a modern internal look. All our furniture is available in a variety of different styles and finishes.

The majority of designs in the Heritage window range are internally glazed for extra peace of mind.



Colours and Finishing Touches

Your windows can be customized from a wide range of styles, frame colours and glazing types to compliment a wide variety of property styles. By using the highest quality materials, these windows will not discolour, lose their strength or corrode over time. The powder coat finish is guaranteed for 10 years.



Windows can be supplied in single or dual RAL colour (one colour inside and another out) polyester powder coat finish. Standard colours are white, black/white^(dual colour), black and brown.



Monkey Tail Handle



Monkey Tail Peg & Stay



Pear Drop Handle

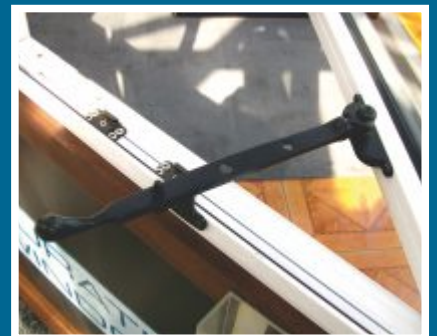

Pear Drop Peg & Stay



Secure Night Vent Facility

Listed Buildings

“Listing is not a preservation order, preventing change. Listing is an identification stage where buildings are marked and celebrated as having exceptional architectural or historic special interest, before any planning stage which may decide a building's future.”

“Listing does not freeze a building in time, it simply means that listed building consent must be applied for in order to make any changes to that building which might affect its special interest. Listed buildings can be altered, extended and sometimes even demolished within government planning guidance. The local authority uses listed building consent to make decisions that balance the site's historic significance against other issues such as its function, condition or viability.”

“If you wish to alter, extend or demolish a listed building in a way that affects its character as a building of special interest, you must first obtain Listed Building Consent from your local planning authority.”

“Each building is different and so there are no sweeping rules for what you can or can't do without consent.”

“Most buildings are very flexible but consent is needed for anything that might risk detracting from what makes that building special.”

From: www.english-heritage.org.uk



Our Heritage Products Have Successfully Been Installed In Grade II Listed Buildings*.

* Please consult your local authority for building consent

Our Heritage Windows Installed In A Grade II Listed Building

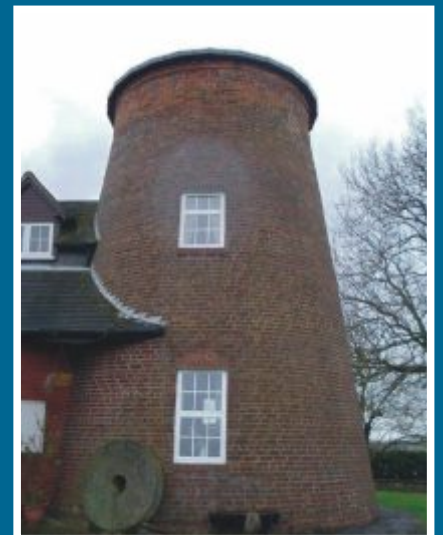
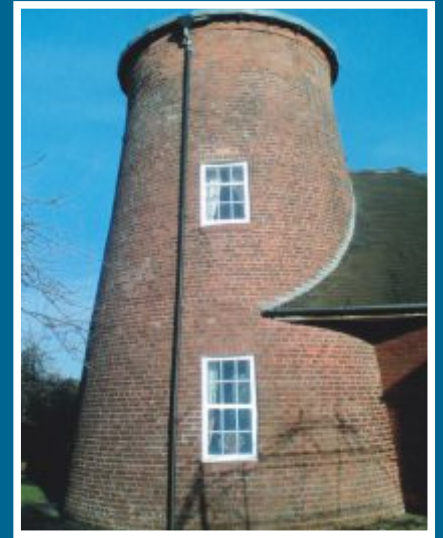

Chelton® Handle Range

With a unique range of Heritage and modern style handles the Chelton® Handle range consists of a modern slim-line handle, an Art Deco style handle and a period Monkey Tail handle. These handles are fitted directly into the glazing bead, for clean lines and for added security. They also have key locking facilities and drive our Chelton Secure™ Locking mechanism. With a choice of three different designs in a range of colours the Chelton® handle range has something to suit every home.

Modern Slim-Line Handle

An exciting new concept in window handles, our patented slim-line Chelton® Modern handles look like no handles you have ever seen before. Blending into the window frame, the discreet, curved, slim-line design looks great on your windows. The flush design barely protrudes into the glass sight-line and will not catch on your nets, curtains, blinds or you.

Colours available include:

Black, White, Silver powder coat, Gold, Chrome, Black chrome and Simulated stainless steel.

Art Deco Handle

The Chelton® Art Deco Handles have been designed to look like traditional steel window handles. They have an Art Deco style that fits in nicely to any period property, and for example when replacing old steel windows.

Colours available include:

Black, White, Silver powder coat, Gold, Chrome, Black chrome and Simulated stainless steel.

Monkey Tail Handle

The Chelton® Monkey Tail Handles have been designed to replicate old Monkey Tail handles. A Classic design that will give your windows an olde worlde charm.

Colours available include:

Black or White only.

Added Security

Our patented Chelton® handle range are all installed directly into the window bead. This new method of concealing the handle fixings makes these handles more secure and tamper proof.

High Security Chelton Secure™ Locking

These handles operate patented Chelton Secure™ Locking. This is a high security multi-point all round window locking system with six plus locking points securing the window on three sides rather than one. When combined with sash jammers on the hinge edge of the window you gain all round window security.



Chelton® Handle Range

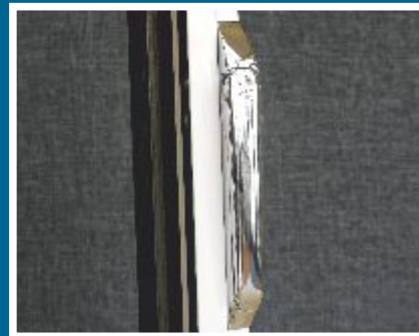

Modern Slim-Line Handle
Chrome Finish

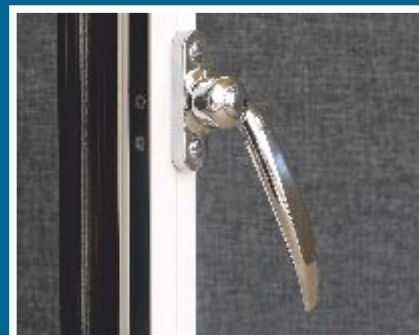

Art Deco Handle
Chrome Finish

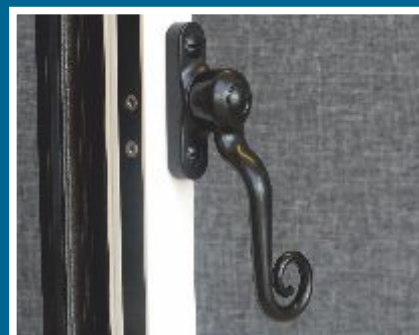

Monkey Tail Handle
Black Finish

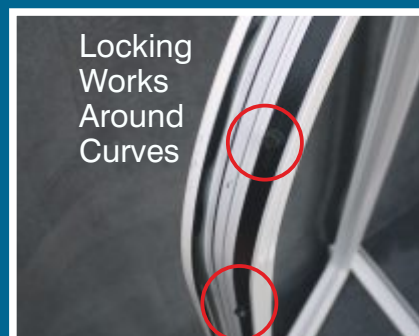

Chelton Secure™ Locking.

Heritage Balcony Door



This aluminium door system is designed as an extremely slim-line Heritage door. This system has the latest polyamide thermal break and is designed to replicate classic steel doors. It has authentic high security butt hinges, a Chelton® slim-line modern interior handle and Chelton Secure™ multi-side door locking.

Our Heritage balcony doors are suitable for new build as well as replacement or refurbishment projects. They are equally at home in a commercial or domestic property.

Styles

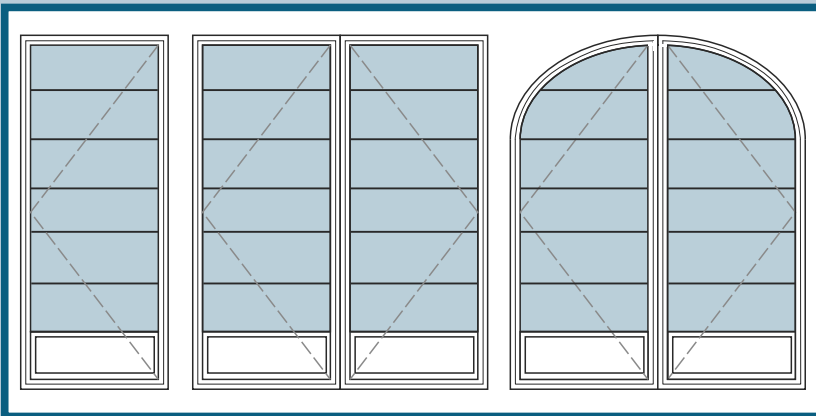

Features

- Slim sight-lines, still with a maximum width of 1800mm.
- Standard colours are white, black/white (dual colour), black.
- Available as single or double doors & can be curved.
- Open out only.
- These balcony doors match our Heritage windows.
- Choice of handles from our Chelton® handle range.
- Modern high security Chelton Secure™ multi-point, multi-side locking that can lock around an arched head section.
- Profile related sash jamming traditional working butt hinges.
- Non-rusting, thermally broken aluminium heritage door profiles.
- Equal or Odd leg frame.
- Polyamide thermal brake for high thermal efficiency.
- 24mm sealed units.
- Suitable for new build as well as refurbishment projects, listed buildings and conservation areas.



Chelton Secure™ Locking



Chelton Flush Handle
Other Handle Styles Available



Kick Plate

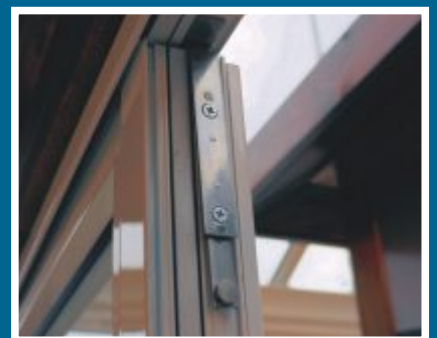

Shoot Bolts On Slave Door



Profile Related, Fully Adjustable
Security Butt Hinges

Curved Openers

Create Beautiful Arched Heritage Windows and Doors

Say good bye to fixed arched windows. The Heritage system can create beautiful curved aluminium windows and doors with openers without any joins, cuts or draughts. Our revolutionary patented Chelton Secure™ locking can follow curves and operate around corners. This allows the lock to pull in tight the three sides of the window, even the head section of an arched window. The lock is driven by our comprehensive Chelton® handle range. Fully secure arched openers have never before been possible unit now.

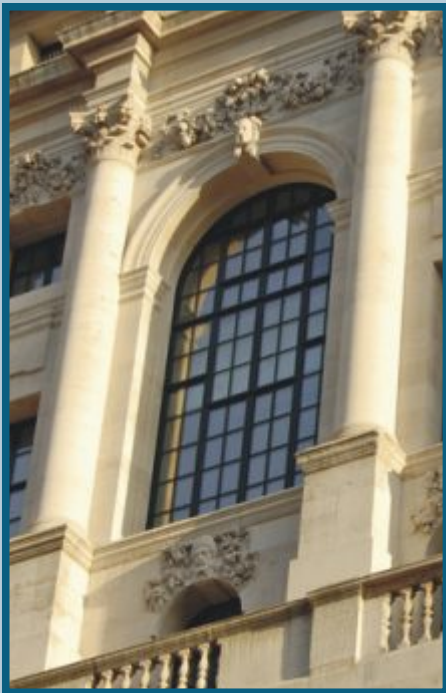

Using the latest computerised bending machines a minimum radius of as little as 500mm can be achieved.

Bending is performed on the latest top of the line computer controlled section bending machines.

A vast collection of forms are used to enable bending of a wide variety of aluminium profiles. Jobs are stored on the machine so that future bends can be matched to previous jobs.

Bending machine

- Short lead times.
- Cost effective.
- Any RAL colour.
- Almost limitless window & door styles.



Arched Window With Bottom Openers



Arched Top Lite



Circular Feature Window



Arched Balcony Door



Chelton Secure™ locking

Sight Lines

Heritage

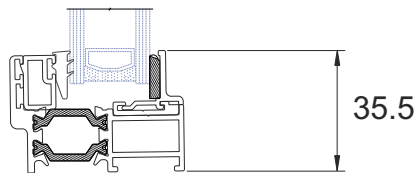
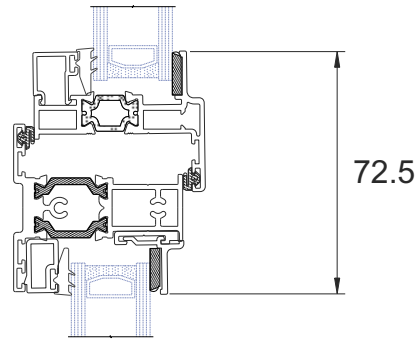
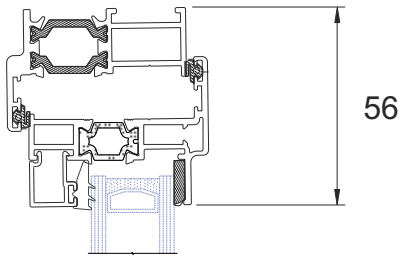

Heritage Chelton Secure

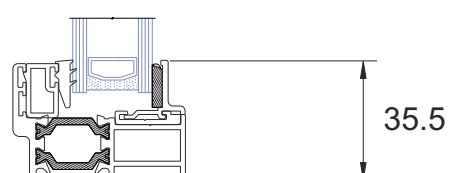
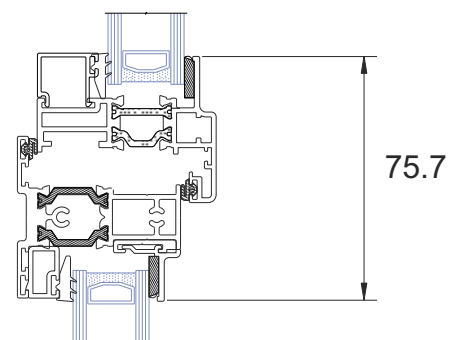
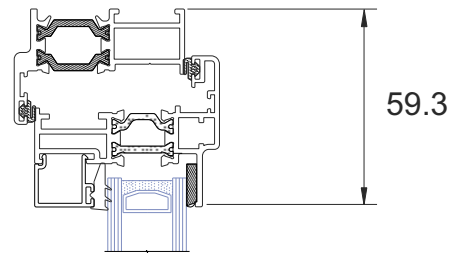

Duration Windows

Units 4-5,
Charfleets Road,
Canvey Island,
Essex. SS8 0PQ

t: 01268 681612 (15 lines)
f: 01268 510058
e: sales@duration.co.uk
w: www.duration.co.uk



DURATION WINDOWS

Supplying high quality aluminium products since 1985

20 Jan 2012